



TE Internal #: 1-88637-3

FFC Connectors, Housing, Wire-to-Board, 24 Position, 2.54 mm [.1 in] Centerline, 2 Row, Socket, Package, Mating Retention, Wire & Cable, Normal

[View on TE.com >](#)

Connectors > PCB Connectors > Wire-to-Board Connectors > FFC, FPC & Ribbon Connectors > FFC Connectors >

2.54mm FFC Connectors Receptacle Housing



FFC Connector Product Type: **Housing**

Connector System: **Wire-to-Board**

Number of Positions: **24**

Centerline (Pitch): **2.54 mm [.1 in]**

Number of Rows: **2**

[All 2.54mm FFC Connectors Receptacle Housing \(143\)](#)

Features

Product Type Features

Connector & Housing Type	Receptacle
FFC Connector Product Type	Housing
Connector System	Wire-to-Board
Sealable	No
Connector & Contact Terminates To	Wire & Cable
Insertion Force Type	Normal

Configuration Features

Compatible With Wire & Cable Type	FFC
Number of Positions	24
Number of Rows	2

Electrical Characteristics

Dielectric Withstanding Voltage (Max)	720 VAC
Insulation Resistance	5000 MΩ
Operating Voltage	300 VAC

Contact Features

Contact Type	Socket
--------------	--------



Mechanical Attachment

Mating Alignment Type	Polarization
Panel Mount Feature Type	Mounting Ears
Mating Retention Type	Detent Window
Mating Retention	With
Mating Alignment	With
Panel Mount Feature	With
Connector Mounting Type	Cable Mount (Free-Hanging)

Housing Features

Housing Material	Nylon
Centerline (Pitch)	2.54 mm [.1 in]
FFC Cable Entry	Straight
Housing Color	Black

Dimensions

Row-to-Row Spacing	2.54 mm [.1 in]
--------------------	-----------------

Usage Conditions

Operating Temperature Range	-65 – 105 °C [-85 – 221 °F]
-----------------------------	-----------------------------

Operation/Application

Circuit Application	Signal
---------------------	--------

Industry Standards

UL Flammability Rating	UL 94V-0
------------------------	----------

Packaging Features

Packaging Quantity	1
Packaging Method	Package

Other

Comment	Use Extraction Tool No. 91093-1 for round wire contacts.
---------	----------------------------------------------------------

Product Compliance

[For compliance documentation, visit the product page on TE.com>](#)

EU RoHS Directive 2011/65/EU	Compliant
EU ELV Directive 2000/53/EC	Compliant







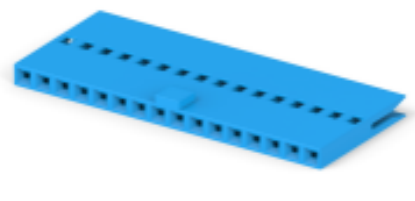
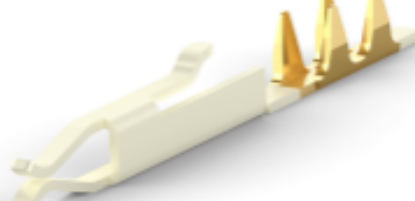

China RoHS 2 Directive MIIT Order No 32, 2016	No Restricted Materials Above Threshold
EU REACH Regulation (EC) No. 1907/2006	Current ECHA Candidate List: JUNE 2022 (224) Candidate List Declared Against: JUNE 2022 (224) Does not contain REACH SVHC
Halogen Content	BFR/CFR/PVC Free, but Br/Cl >900 ppm in other sources.
Solder Process Capability	Not applicable for solder process capability

Product Compliance Disclaimer

This information is provided based on reasonable inquiry of our suppliers and represents our current actual knowledge based on the information they provided. This information is subject to change. The part numbers that TE has identified as EU RoHS compliant have a maximum concentration of 0.1% by weight in homogenous materials for lead, hexavalent chromium, mercury, PBB, PBDE, DBP, BBP, DEHP, DIBP, and 0.01% for cadmium, or qualify for an exemption to these limits as defined in the Annexes of Directive 2011/65/EU (RoHS2). Finished electrical and electronic equipment products will be CE marked as required by Directive 2011/65/EU. Components may not be CE marked. Additionally, the part numbers that TE has identified as EU ELV compliant have a maximum concentration of 0.1% by weight in homogenous materials for lead, hexavalent chromium, and mercury, and 0.01% for cadmium, or qualify for an exemption to these limits as defined in the Annexes of Directive 2000/53/EC (ELV). Regarding the REACH Regulation, the information TE provides on SVHC in articles for this part number is based on the latest European Chemicals Agency (ECHA) 'Guidance on requirements for substances in articles' posted at this URL: <https://echa.europa.eu/guidance-documents/guidance-on-reach>

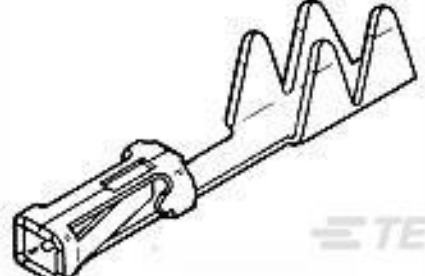
Compatible Parts

 <p>TE Part # CAT-F439-S01339254 2.54mm FFC Connectors Socket Contacts</p>	 <p>TE Part # CAT-F439-S01339127 1.27mm FFC Connectors Socket Contacts</p>	 <p>TE Part # CAT-F439-P65127 FFC Connector Pin Contacts, 1.27 mm</p>	 <p>TE Part # CAT-F439-P65254 2.54mm FFC Connectors Pin Contacts</p>
 <p>TE Part # 1-88190-0 024 HOUSING FFC PIN DR 100CL</p>	 <p>TE Part # 1761852-1 FFC RCPT HP 100SNPB RL NO LUBE</p>	 <p>TE Part # 1-487137-1 FFC SOLDER TAB FULL 100 SN</p>	 <p>TE Part # 487787-3 FFC SPLICE CONTACT L.P.</p>

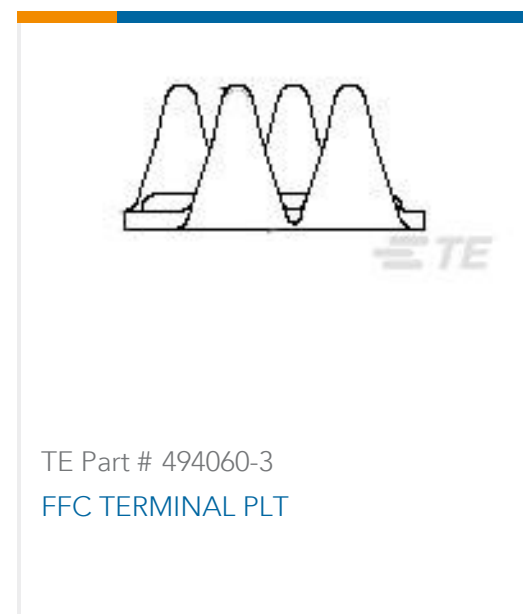

Documents

Product Drawings

[024 HOUSING FFC RCPT DR 100CL](#)

English

CAD Files

[3D PDF](#)

3D

Customer View Model

[ENG_CVM_CVM_1-88637-3_AN_c-1-88637-3-an.2d_dxf.zip](#)

English

Customer View Model

[ENG_CVM_CVM_1-88637-3_AN_c-1-88637-3-an.3d_igs.zip](#)

English

Customer View Model

[ENG_CVM_CVM_1-88637-3_AN_c-1-88637-3-an.3d_stp.zip](#)

English

By downloading the CAD file I accept and agree to the [Terms and Conditions](#) of use.

Product Specifications

[Application Specification](#)

English

Instruction Sheets

[Instruction Sheet \(U.S.\)](#)

English

[Extraction Tool for Flexible Flat Cable \(FFC\)](#)

English

[Instruction Sheet \(U.S.\)](#)

English

[Extraction Tools](#)

English

Agency Approvals

[CSA Certificate](#)

English

